

QUANTUM Q9000VOIP SERIES MANUAL



TABLE OF CONTENTS

[Table of Contents Limitation of Liability](#)

[Products Limited Warranty](#)

[Limited Warranty Limits and Exclusions](#)

[CHAPTER 1 GETTING STARTED](#)

[CHAPTER 2 INSTALLATION AND WIRING DIAGRAM](#)

[General Wiring Diagram](#)

[Power Wiring Diagram](#)

[VOIP Diagram](#)

[Door Strike Wiring Diagram](#)

[Input Devices and Door Sensor Wiring Diagram](#)

[Satellite System Wiring Diagram](#)

[CHAPTER 3 KEYPAD CORRELATION TABLE](#)

[CHAPTER 4 PROGRAMMING](#)

[Log-in to Programming Mode](#)

[Function Code 15: Initializing Event Recording](#)

[Function Code 16: Auto Unlock Schedule \(AUS\)](#)

[Function Code 17: Time Zone \(TMZ\)](#)

[Function Code 18: Holiday Zone \(HLD\)](#)

[Function Code 19: Directory Digit](#)

[Function Code 20: AUXIN1](#)

[Function Code 21: AUXIN2](#)

[Function Code 22: Do Not Disturb](#)

[Function Code 23: Lock-out Count](#)

[Function Code 24: Alarm](#)

[Function Code 25: Keypad Beep](#)

[Function Code 26: Door Beep](#)

[Function Code 27: Talk Time](#)

[Function Code 28: Unlock Relay 1 Time](#)

[Function Code 29: Unlock Relay 2 Time](#)

[Function Code 33: Temporary Code](#)

[Function Code 34: Special Code](#)

[Function Code 35: Temporary Card](#)

[Function Code 36: Special Card](#)

[Function Code 38: System Acknowledge](#)

[Function Code 39: Disable and Enable Remote Access](#)

[Function Code 40: DTMF Relay 1](#)

[Function Code 41: DTMF Relay 2](#)

[Function Code 42: Relay 2 Mode](#)

[Function Code 43: Do Not Disturb Zone](#)

[Function Code 44: Disable Time Zone Relay](#)

[Function Code 45: Relay 1 and 2 Unlock Timer](#)

[Function Code 46: Firmware Version](#)

[Function Code 48: PBX Enable](#)

[Function Code 00: Change Master Code](#)
[Function Code 01: Add New Tenant Directory](#)
[Function Code 02: Edit Existing Directory](#)
[Function Code 03: Delete Tenant Directory](#)
[Function Code 04: Clear All Tenant Directories](#)
[Function Code 05: Enable or disable Call](#)
[Function Code 06: Add New Access Code](#)
[Function Code 07: Delete Access Code](#)
[Function Code 08: Clear All Access Codes](#)
[Function Code 09: Access Code Digit](#)
[Function Code 10: Add New Card or Transmitter](#)
[Function Code 11: Delete Card or Transmitter](#)
[Function Code 12: Clear All Cards and Transmitters](#)
[Function Code 13: Set Time](#)
[Function Code 14: Set Date](#)

[Function Code 49: Edit Existing Access Code, Temporary Code and Special Code](#)
[Function Code 50: Erase Memory to Factory Default](#)
[Function Code 51: Welcome Screen](#)

CHAPTER 5 OPERATIONS

[Call from the System](#)
[Opening Door Remotely](#)
[Opening Door Using Access Code, Temporary Code and Special Code](#)
[Opening Door Using Card, Temporary Card, and Special Card](#)
[Opening Door Using Transmitter, Temporary Code Transmitter and Special Code Transmitter](#)
[Extending Talk Time](#)
[Call the System from Remote Location](#)

CHAPTER 6 QWCM

LIMITATIONS OF LIABILITY

This manual is subject to change without notice.

Pach and Company is not liable for any errors that might occur from use of this document, nor is any commitment to update the information herein implied.

Pach and Company does not assume any liability for any damages, which may arise in installation or use of the Quantum Q9000VOIP Series Series Series Pach and Company does not assume liability for any incompatibility between the Quantum Q9000VOIP Series Series Series and users devices.

Pach & Company reserves the right to make changes without prior notice to any products in order to improve reliability, function or design.

PRODUCTS LIMITED WARRANTY

If your product does not work properly because of a defect in materials or workmanship, Pach and Company (referred to as the warrantor) will, for the length of the period indicated on the chart below, which starts with the date of original purchase (Limited Warranty Period), at its option either (a) repair your product with new or refurbished parts or (b) advance replacement with new or refurbished product. The decision to repair or advance replacement will be made by the warrantor. Advance replacement will be ship UPS ground under the warranty period with no charge. *The defective product must be return to Pach and Company within 15 days after receiving the advanced replacement otherwise you will be billed the full amount.*

Parts: Two (2) year, does not cover parts needed to re-install the product by the installer

Labor: Two (2) year, does not cover installation labor

Cards, Fobs and Transmitters warranted for 90 days

LIMITED WARRANTY LIMITS AND EXCLUSIONS

This limited warranty **ONLY COVERS** failures due to defects in materials or workmanship, and **DOES NOT COVER** normal wear and tear or cosmetic damage.

The Limited Warranty **ALSO DOES NOT COVER** damages which occurred in shipment, or failures which result from accidents, misuse, abuse, neglect, bug infestation, mishandling, misapplication, alteration, faulty installation, setup adjustment, misadjustment of consumer controls, improper maintenance, power line surge, lightning damage, modification, introduction to sand, humidity or liquids or product has been installed by non-license installer or damage that is attributable to acts of God.

ADVANCE REPLACEMENT can only be issued by Pach and Company Technical Department free of charge and transport by standard transportation (UPS Ground, Standard US mail, whichever is applicable). Our Technical Department has the right to decline advance replacement. It is your responsibility to return the defective part at your cost.

THERE ARE NO EXPRESS WARRANTIES EXCEPT AS LISTED UNDER LIMITED WARRANTY COVERAGE . THE WARRANTOR IS NOT LIABLE FOR INCIDENTAL OR CONSEQUENTIAL DAMAGES RESULTING FROM THE USE OF THIS PRODUCT, OR ARISING OUT OF ANY BREACH OF THIS LIMITED WARRANTY. (As examples, this excludes damages for lost time, lost calls or messages, cost of having a unit removed or re-install if applicable, travel to and from the servicer.

ALL EXPRESS AND IMPLIED WARRANTIES, INCLUDING THE WARRANTY OF MERCHANTABILITY, ARE LIMITED TO THE PERIOD OF THE LIMITED WARRANTY.

Some states do not allow the exclusion or limitation of incidental or consequential damages, or limitation on how long an implied warranty lasts, so the exclusions may not apply to you.

This Limited Warranty gives you specific legal rights and you may also have other rights which vary from state to state. If a problem with this product develops during or after the Limited Warranty period, you may contact your dealer/installer. If the problem is not handled to your satisfaction, then call Pach and Company at 1-888-678-7224.

PARTS AND SERVICE, WHICH ARE NOT COVERED BY LIMITED WARRANTY, ARE YOUR RESPONSIBILITY.

CHAPTER 1 Getting Started



Introduction

Pach & Company thanks and congratulates you on the purchase of your Quantum Q9000VOIP Series Series Series Telephone Entry Access Control Systems.

The manual is designed to guide you through the proper programming and use of the Quantum Q9000VOIP Series Series Series It is important for you to read and follow the manual completely.

The product comes with two years Limited Warranty, see above for more detail

System Descriptions

The Quantum Q9000VOIP Series Series Series is multi tenant telephone entry system.

1. Analog Terminal Adapter is included. Sign-up for Google Voice and call 1-888-678-7224 to activate the ATA.
2. Capacity 900 tenants

[See Chapter 2 for more detail](#)

Specifications

Input power: 12VAC 40VA (12VAC supplied), 12VDC 3.0A

Minimal Current consumption: 750-100mA

DIMENSION: Surface: 13-9/16 "(H) x 11-1/4 "(W) x 3-3/4 "(D).

Full-flush: 13-7/8"(H) x 11-9/16"(W) x 3-3/4"(D)

Mounting Ring (full-flush):

Inside: 13-3/4" (H) x 12"(W) x 3-11/16"(D)

Outside: 18" (H) x 15-5/8" (W)

1x16 Liquid Crystal Display (LCD)

Built-in 26 Bit Wiegand Card Reader

RS-485 for Satellite system (up to eight satellite)

Two on-board relays

Two Auxiliary inputs

Operating environment 10°F-140°F

Relative Humidity 0%-95% non-condensing

Double 3/4" knock-out on the back and bottom panel

Features

Internet Browser Programming

Event recording 1200 Event Buffer

Automatic Enrollment

900 Tenants, 900 Access Codes and 2000 cards or fobs

20 programmable time zones, 10 programmable auto-unlock schedules and 20 holiday schedules

10 programmable temporary cards and access codes for limited use

10 programmable unlock hold cards and access codes

Program blocks of cards and blocks of codes

Accessories and Replacement parts

Visit our web site [index.htm](#)

Unpacking the System

All the items below come with the Quantum Q9000VOIP Series Series Series Contact Pach and Company for missing part(s) at (888) 678-7224, Monday-Friday 7:30 AM -3:30 PM Pacific Standard Time.



CHAPTER 2 Installation and Wiring Diagram



Follow the wiring diagram carefully. Improper installation will void the warranty. *Please call technical support in case you have any difficulties during the installation.* Click the selection below for different applications

[General Wiring Diagram](#)

[Power Wiring Diagram](#)

[VOIP Diagram](#)

[Door Strike Wiring Diagram](#)

[Input Devices and Door Sensor Wiring Diagram](#)

[Satellite System Wiring Diagram](#)

2.1 General Wiring Diagram





Figure 2.1
General Wiring Diagram

2.2 Power Wiring Diagram

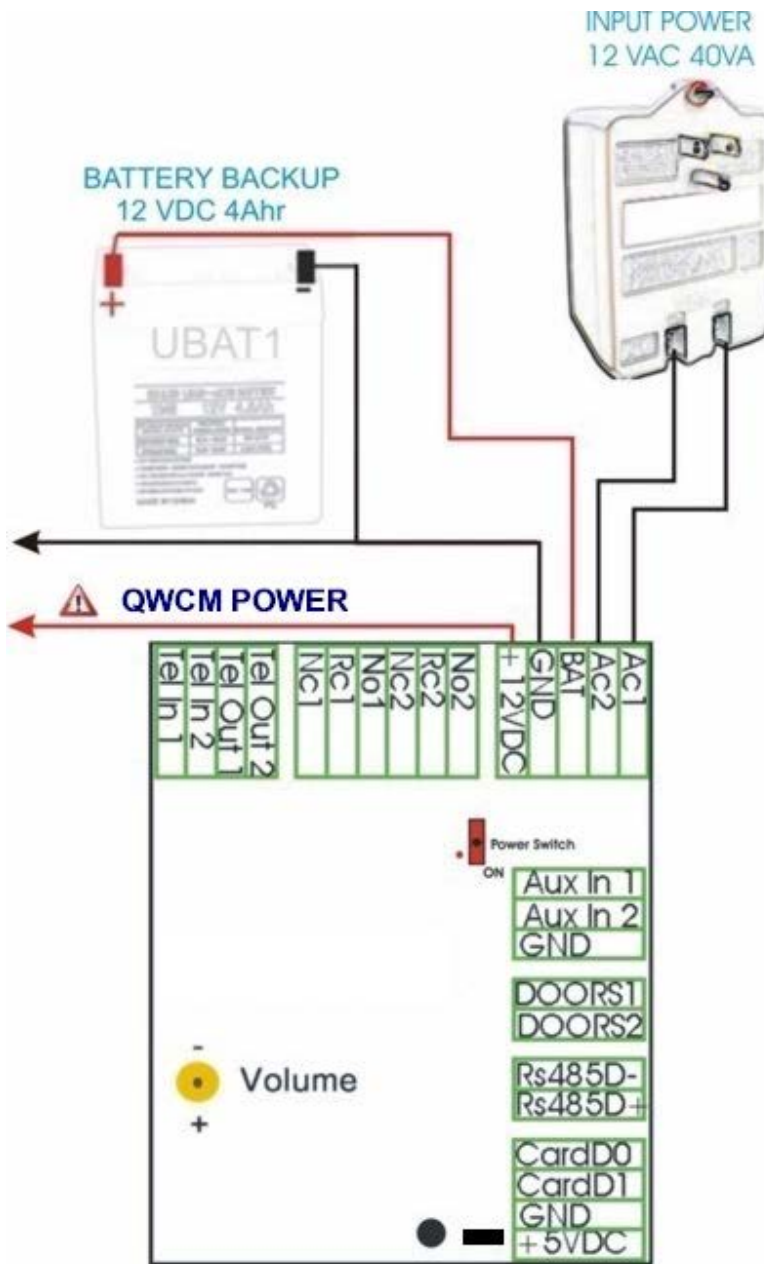

Figure 2.2
Power Wiring Diagram

2.3 VOIP Wiring Diagram

! *Compatibility issue may occur between the Quantum Q9000VOIP Series Series Series and your VOIP line.*

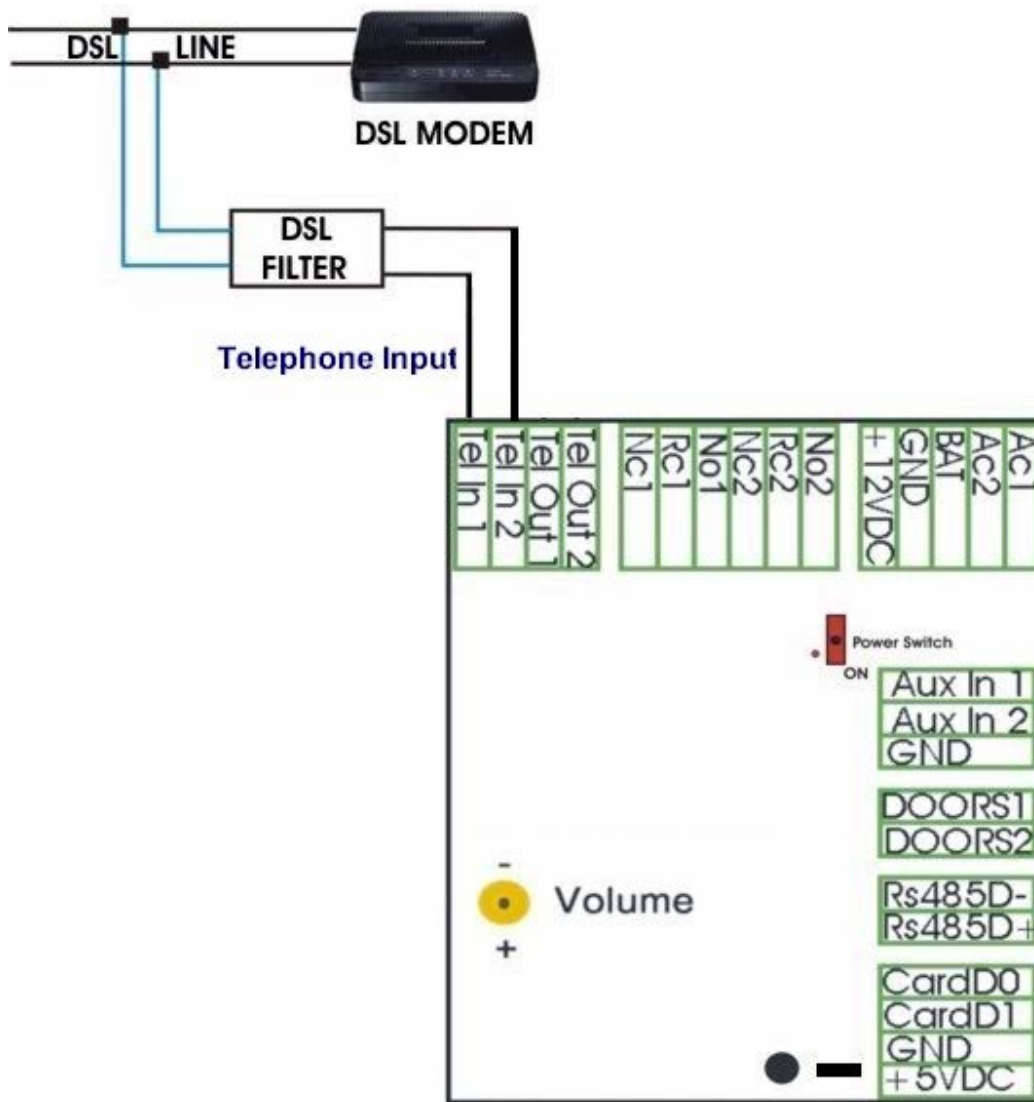

Figure 2.3
VOIP Wiring Diagram

2.4 Door Strike Wiring Diagram

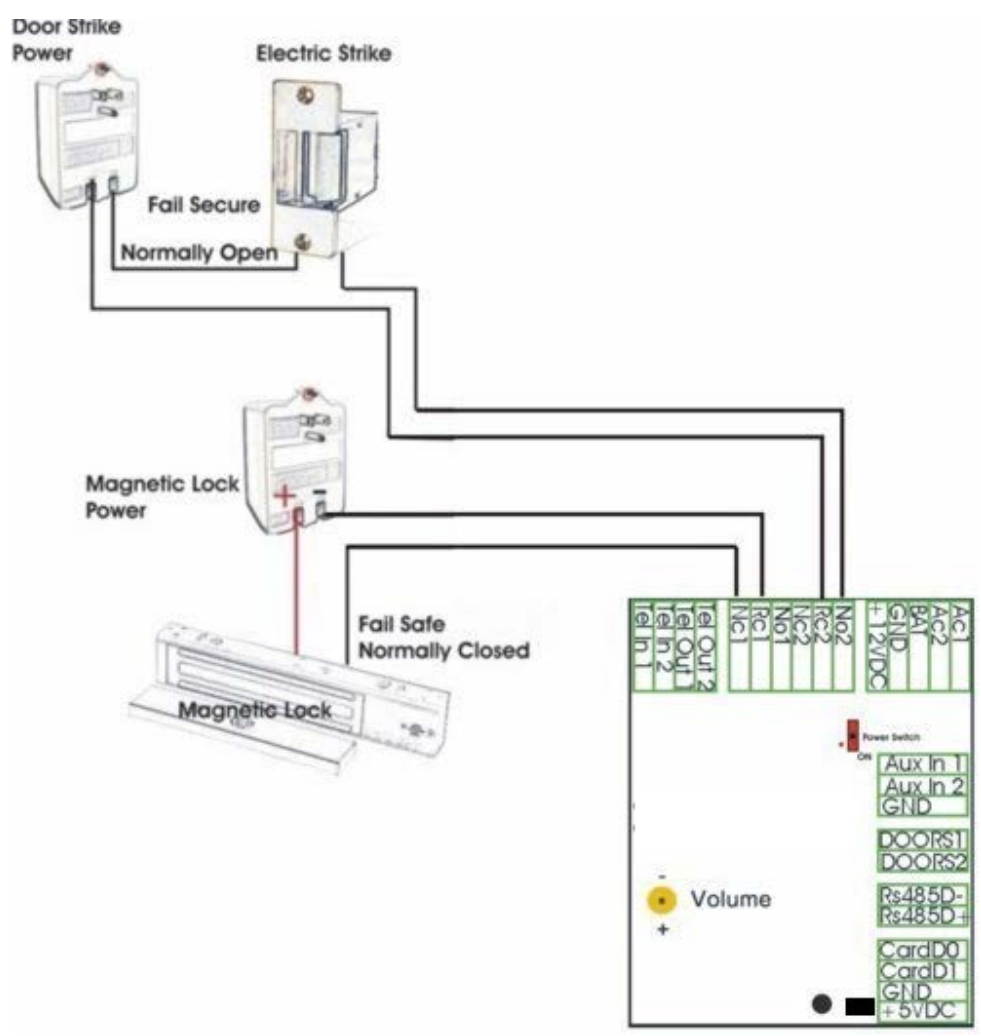

Figure 2.4
Door Strike Wiring Diagram

2.5 Input Device and Door Sensor Wiring Diagram

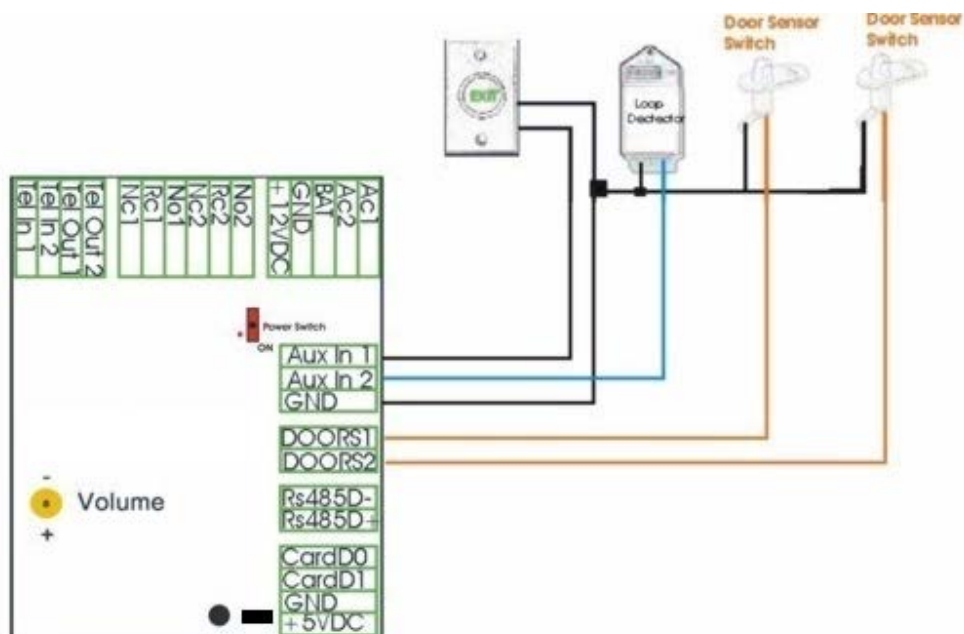

Figure 2.5
Input Device and Door Sensor Wiring Diagram

2.6 Satellite System Wiring Diagram

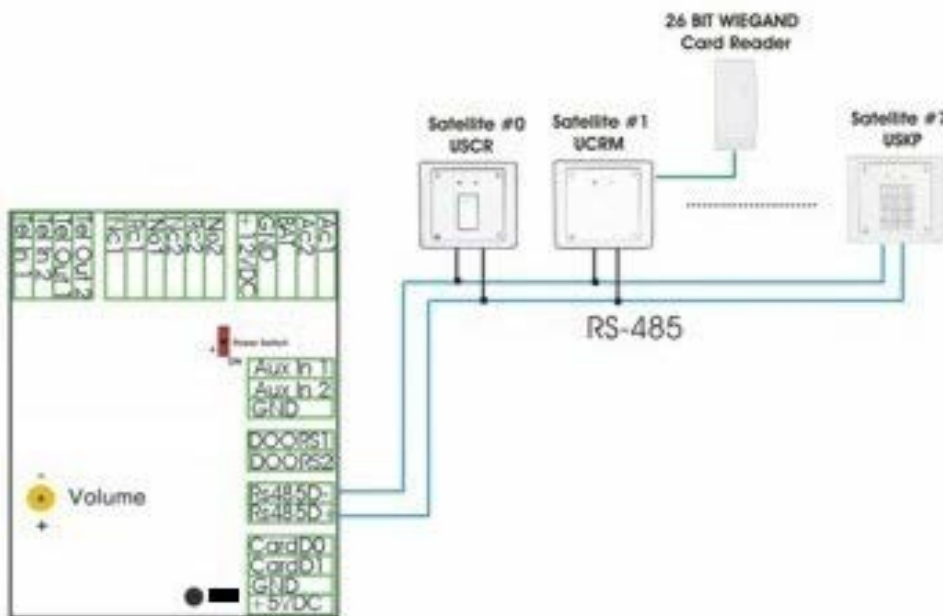

Figure 2.6
Satellite System Wiring Diagram

Assuming all wiring has been done properly according to [chapter 2](#) then turn the system's power on as shown on [figure 2.1 number 10](#). The LCD will go into a cycling mode as below

LCD Display OK --- Flash OK --- RTC OK --- DTMF OK --- INIT START --- INIT COMPLTE --- SCROLLING

CHAPTER 3

Keypad Correlation Table



The QR5 buttons are lighted. Below are the correlation table for each key.

























	= 1 _ . , ? : ; ! @ + - * / = # < > %					M N O m n o 6
	A B C a b c 2					P Q R S p q r s 7
	D E F d e f 3					T U V t u v 8
	G H I g h i 4					W X Y Z w x y z 9
	J K L j k l 5					SPACE
	Cancel call, Erase incorrect letter or number, exit programming (*)					CALL, ENTER, EXCEPT PROGRAM

Figure 3.1

CHAPTER 4 Programming



Log-in to Programming Mode



1. Press 0 and # simultaneously, then release, the welcome screen will stop scrolling.
2. Enter 4-digit master code (default=0000) then press # (if you do not know the master code, see [chapter 2 step 8](#))

SELECT FUN:

Function Code 00 - Change Master Code



1. [Log-in to programming](#)
2. Enter 00 then #

MASTER CODE:0000

3. Enter new master code then press #

Function code 01 - Add New Tenant Directory



A tenant directory consists of directory code such as apartment number or any number, tenant's name and phone number.

Up to 1000 tenant directories can be programmed.

1. [Log-in to programming](#)

2. Enter 01 then #

FWD DIR(0-9):0

3. Enter directory number 0-9 (*directory is in single digit and cannot be changed*) then #

NAME

----- see [Chapter 3](#) for keypad layout

4. Enter name up to 16 characters (*name can be a person real name, apartment number, etc., directory will be sorted in alphabetical order*) then press #

PHONE NUM

5. Enter the tenant phone number up to 16-digit (*phone number can be land line number, cellular number or Voice over IP (VOIP) number. Note: VOIP phones may have problems releasing door*) then press #.

[Return to step 3 to enter another tenant directory](#)

Function Code 02 - Edit Existing Tenant Directory



1. [Log-in to programming](#)

2. Enter 02 then #, the display will show

FWD DIR(0-9):0

3. Enter tenant directory number to be edited then #

NAME

PACH AND COMPANY

Enter new name up to 16 characters then press # *or press # without entering anything to keep the existing name*

PHONE NUM

----- see [Chapter 3](#) for keypad layout

4. Enter the a new tenant phone number up to 16-digit then press # or *press # without entering anything to keep the existing number.*

[Return to step 3 to edit another tenant directory](#)

Function Code 03 - Delete Tenant Directory

1. [Log-in to programming](#)
2. Enter 03 then #

DEL FWD(0-9):_

3. Enter the tenant directory to be deleted (0-9) then press #

DELETED

if directory exists

NOT EXIST

if directory does not exist

Function Code 04 - Clear All Tenant Directories

1. [Log-in to programming](#)
2. Enter 04 then #

CLR ALL FWD(1):

3. Do the following:
 - Press 1 (to clear all directories) then press #

- Press * to cancel

ALL CLR

Function Code 05 - Call Forwarding

Enable or disable call. Default setting= 1 (enable). If 1 (disable) is selected, the system can't make calls

1. [Log-in to programming](#)
2. Enter 30 then #

FWD(E=1, D=0):1

3. Enter 0= disable (default) or 1= enable then press #

Function Code 06 - Add New Access Code

An access code is a keyless entry code to unlock the door. An access code can be programmed in 4, 5, 6, 7, or 8 digits, see [function code 09](#) to change the access code's number of digits. Up to 100 access codes can be programmed.

1. [Log-in to programming](#)
2. Enter 06 then #

NEWCODE:

3. Enter the access code (4-8 digit, see [function code 09](#)), then press #

NAME

----- see [Chapter 3](#) for keypad layout

4. Enter name up to 16 characters, then press #

DOOR(1,2,3):

5. Enter door 1 or 2, or 3 for both, then press #

TMZ SET(1-3):

6. Enter time zone 1-3 then press #

TMZ NO(0-20):_ _

7. Enter 00 (*24 hours*) - 20 see [function code 17](#) then press #

SAT ID: _ _ _ _ _

8. Enter satellite system ID 0-7 (*enter 0 if no satellite connected to the QR5*) then press #

Another(0-1):_

9. Enter
 0= no more additional time zone then press # and return to [step 3](#) to program another access code
 1= add additional time zone then press # and return to [step 6](#)
 * = exit programming

Function Code 07 - Delete Access Code

1. [Log-in to programming](#)
2. Enter 07 then #

DELCODE: _ _ _ _

3. Enter code to be deleted then press #

CODE DELETED

if access code exists

CODE NOT EXIST

if access code does not exist

Repeat this step to delete another code

Function Code 08 - Clear All Access Codes

1. [Log-in to programming](#)
2. Enter 07 then #

CLR ALL CODE(1) _

3. Enter

1 to clear all access code then press #

ALL CODE CLEARED

or

* to cancel

Function Code 09 - Access Code Digit



1. [Log-in to programming](#)
2. Enter 09 then #

CODE DIGIT: 4

3. Enter 4, 5, 6, 7 or 8 (default setting is 4 digit) then press #

Function Code 10 - Add New Card or Transmitter



A maximum of 100 cards or transmitters can be programmed into the Quantum Q9000VOIP Series Series Series

1. [Log-in to programming](#)
2. Enter 10 then #

NEWCARD: _ _ _ _ _

3. Present the card in front of the card reader black window, the number will register automatically (or enter the last 8 digits of the number on the card) then press # or press the transmitter button (the number will automatically register) then press #

NAME

see [Chapter 3](#) for keypad layout

4. Enter name up to 16 characters then press #

DOOR(1,2,3):

5. Enter door 1 or 2, or 3 for both then press #

TMZ SET(1-3):

6. Enter time zone 1-3 then press #

TMZ NO(0-20):_ _

7. Enter 00 (*24 hours*) - 20 see [function code 17](#) then press #

SAT ID: _ _ _ _ _

8. Enter satellite system ID 0-7 (**enter 0 if no satellite connected to the QR5**) then press #

Another(0-1):_

9. Enter
 0= no more additional time zone then press # and return to [step 3](#) to add program another card
 1= add additional time zone then press # and return to [step 6](#)
 * = exit programming

Function Code 11 - Delete Card or Transmitter

1. [Log-in to programming](#)
2. Enter 11 then #

DELCARD: _ _ _ _ _

3. Present the card in front of the card reader black window, the number will register automatically (or enter the last 8-digits of the number on the card) then press #

CARD DELETED

if card exists

CARD NOT EXIST

if card does not exist

Repeat this step to delete another code

Function Code 12 - Clear All Cards or Transmitters



1. [Log-in to programming](#)
2. Enter 12 then #

CLEAR ALL CARD(1) _

3. Enter

1 to clear all cards or transmitters then press #

ALL CARD CLEARED

or

* to cancel

Function Code 13 - Set Time



1. [Log-in to programming](#)
2. Enter 13 then #

TIME (HH:MM) 13:52

3. Enter
HH= in military time
MM= minute
the press #

Function Code 14 - Set Date



1. [Log-in to programming](#)
2. Enter 14 then #

DATE: 2011/08/11

3. Enter YYYY/MM/DD

YYYY= year
MM= Month
DD= Date
then press #

DAY(0=SUN): 2

4. Enter

0= Sunday, **1**= Monday, **2**= Tuesday, **3**= Wednesday, **4**= Thursday, **5**= Friday, **6**= Saturday
then press #

DAYLIGHT(0-1):1

5. Enter 0= NO Daylight Saving Zone (Hawaii, Indiana and Arizona) 1=Daylight Saving Zone
then press #

Function Code 15 - Initializing Event recording



The events are stored in the RAM buffer. The Event RAM buffer can hold 2000 events. The Events are stored as first in first out (FIFO). This function code will clear the event buffer.

1. [Log-in to programming](#)

2. Enter 15 then #

EVENT INIT(1):_

Enter 1 then # to clear event buffer

INIT EVENT BUF...

or

* to cancel deletion

Function Code 16 - Auto Unlock Schedule (AUS)



Unlocking and locking the door as program automatically. if the open time is 06:00 and close time 18:00, door 1,2 or both will unlock at 06:00 am and close at 06:00 pm. 10 AUS can be programmed.

1. [Log-in to programming](#)

2. Enter 16 then #

AUS NO(0-9):_

3. Enter AUS (0-9) then press #

ADD=1 DEL=0:_

4. Enter
0= Delete the existing AUS the press #

DELETED

or

1= Add AUS then press #

OPEN TIME: _ _ _ _

5. Enter open time in military then press #

CLOSE TIME: _ _ _ _

6. Enter close time in military then press #

DAY(0-6) _ _ _ _ _ _

7. Enter
0= Sunday, **1**= Monday, **2**= Tuesday, **3**= Wednesday, **4**= Thursday, **5**= Friday, **6**= Saturday
then press #

DOOR(1-3):_

8. Enter
1= Relay 1 (door 1)
2= Relay 2 (door 2)
3= Both relay 1 and 2
then press #
9. [Return to step 3 to enter another AUS](#)

Function Code 17 - Time Zone (TMZ)



A maximum of 20 Time Zone can be programmed and up to three time zone can be assigned to each access code or card to allow access during a certain time of the day.

1. [Log-in to programming](#)

2. Enter 17 then #

TMZ NO(0-20):_ _

3. Enter 01-20 (00=24 hours access automatically) then press #

ADD=1 DEL=0:_

4. Enter

0= Delete the existing time zone then press #

DELETED

or

1= add new time zone then press #

START TIME: _ _ _ _

5. Enter start time in military then press #

END TIME: _ _ _ _

6. Enter end time in military then press #

DAY(0-6) _ _ _ _ _

7. Enter

0= Sunday, **1**= Monday, **2**= Tuesday, **3**= Wednesday, **4**= Thursday, **5**= Friday, **6**= Saturday then press #

[Return to step 3 to program more time zone](#)

Function Code 18 - Holiday Zone (HLD)

HLD is to ever ride Time Zone (TMZ) and Auto Unlock Schedule (AUS) during the holidays. Up to 20 Holiday Zone can be programmed

1. [Log-in to programming](#)

2. Enter 18 then #

HLD NO(1-20):_ _

3. Enter 01-20 then press #

ADD=1 DEL=0:_

4. Enter

0= Delete the existing holiday zone then press #

DELETED

or

1= add new holiday zone then press #

HOLIDAY:_ _ _ _

5. Enter month and date (i.e. 0704 for U.S.A Independence Day) then press #
[Return to step 3 to add more holiday zones.](#)

Function Code 19 - Directory Digit



Directory digit is a unique number that must be assigned for each tenant. Directory digit can be an apartment number. By default is set to 3 but it can be changed to 2,3 or 4 digit. It also uses to do [direct call](#).

1. [Log-in to programming](#)
2. Enter 19 then #

DIR DIGIT: 3

3. Enter 2, 3 or 4 digit then press #

Function Code 20 - AUXIN1



AUXIN1 is used for input device such as postal lock, infrared sensor, exit button, etc..AUXIN1 is associated with relay 1

1. [Log-in to programming](#)
2. Enter 20 then #

AUXIN1:0

3. Enter
 0= disable (default setting)

- 1= Enable control by relay 1 open door interval, see [function code 28](#)
 - 2= relay 1 control by AUXIN1
- then press #

Function Code 21 - AUXIN2



AUXIN2 is used for input device such as postal lock, infrared sensor, exit button, etc.. AUXIN2 is associated with relay 2

1. [Log-in to programming](#)
2. Enter 21 then #

AUXIN2:0

3. Enter
 - 0= disable (default setting)
 - 1= Enable control by relay 2 open door interval, see [function code 29](#)
 - 2= relay 2 control by AUXIN2then press #

Function Code 22 - Do Not Disturb



If the Do Not Disturb is enabled visitors can't call from the system

1. [Log-in to programming](#)
2. Enter 21 then #

NO DIST EN(1):0

3. Enter 0= disable, 1= enable then press #

Function Code 23 Lock-out Count



The system will be disabled in about 60 seconds after pressing invalid access code or swiping invalid card as specified on the Lock-out Count.

1. [Log-in to programming](#)
2. Enter 23 then #

LOCKOUT CNT:3

3. Enter 1-9 (default=3) then press #

Function Code 24 Alarm



The system will make have warning alarm if invalid code or card has been enter according to the setting on [function code 23](#).

1. [Log-in to programming](#)
2. Enter 24 then #

ALARM NO(0-3):1

3. Enter
0= disable, **1**=disable system for 60 seconds and local beep (default setting), **2**= disable system for 60 seconds with no beep
3= call directory (0-9) then press #

Function Code 25 Keypad Beep



Turn the keypad press beep On or Off

1. [Log-in to programming](#)
2. Enter 25 then #

KEY BEEP(0-1):1

3. Enter 0= off, 1= On (default) then press #

Function Code 26 Door Beep



Turn the door beep On or Off

1. [Log-in to programming](#)
2. Enter 26 then #

DOOR BEEP(0-1):1

3. Enter 0= off, 1= On (default) then press #

Function Code 27 Talk Time



The amount of time the visitor can talk to the tenant. The timer starts as soon as the system is offhook.

1. [Log-in to programming](#)
2. Enter 27 then #

TALK TIME:060

3. Enter 10-240 seconds then press #

Function Code 28 Unlock Relay 1 Time



The amount of time for relay 1 to trigger.

1. [Log-in to programming](#)
2. Enter 28 then #

DOOR1 TIME:012

3. Enter 01-99 (second) then press #

Function Code 29 Unlock Relay 2 Time



The amount of time for relay 2 to trigger.

1. [Log-in to programming](#)
2. Enter 29 then #

DOOR2 TIME:012

3. Enter 01-99 (second) then press #

Function Code 33 Temporary Code

The code will be expired after being used a certain amount of times specified (1-10 times) in the programming, Up to 10 temporary codes can be programmed.

1. [Log-in to programming](#)

2. Enter 33 then #

TEMP CODE(0-1)

3. Enter 0= delete existing temporary code or 1= add temporary code then press #

CODE NO(1-10): _ _

4. Enter code number 01-10 then press #

NEWCODE:

5. Enter 4-8 digit code, see digit setting on [function code 09](#)

NAME

----- see [Chapter 3](#) for keypad layout

6. Enter name then press #

DOOR(1,2,3):

7. Enter 1= relay 1(door 1), 2= relay 2 (door 2) or 3= both relay then press #

TMZ SET(1-3):

8. Enter time zone set 1-3 then press #

TMZ NO(0-20): _ _

9. Enter 00 (*24 hours*) - 20 see [function code 17](#) then press #

SAT ID: _ _ _ _ _

10. Enter Sat id 0-7 then press # (enter 0 if no satellite connected to the QR5)

Another(0-1): _

11. Enter
 0= no more additional time zone then press # and return to [step 3](#) to program another temporary code
 1= add additional time zone then press # and return to [step 8](#)
 * = exit programming

Function Code 34 Special Code



The code can be use to unlock hold (open hold) and use same code again to lock (close) door or gate. Up to 10 special codes can be programmed.

1. [Log-in to programming](#)
2. Enter 34 then #

SPEC CODE(0-1): _

3. Enter 0= delete 1= add then press #

CODE NO(1-10): _ _

4. Enter code 01-10 then press #

NEWCODE:

5. Enter 4-8 digit code, see digit setting on [function code 09](#)

NAME

see [Chapter 3](#) for keypad layout

6. Enter name then press #

DOOR(1,2,3):

7. Enter 1= relay 1(door 1), 2= relay 2 (door 2) or 3= both relay then press #

TMZ SET(1-3):

8. Enter time zone 1-3 then press #

TMZ NO(0-20): _ _

9. Enter 00 (*24 hours*) - 20 see [function code 17](#) then press #

SAT ID: _ _ _ _ _

10. Enter Sat ID 0-7 then press # (*enter 0 if no satellite connected to the QR5*)

Another(0-1): _

11. Enter
0= no more additional time zone then press # and return to [step 3](#) to program another temporary code
1= add additional time zone then press # and return to [step 8](#)
* = exit programming

Function Code 35 Temporary Card

The card will be expired after being used a certain amount of times specified (1-10 times) in the programming, Up to 10 temporary cards can be programmed.

1. [Log-in to programming](#)
2. Enter 35 then #

TEMP CARD(0-1): _

3. Enter 0= delete 1= add then press #

CARD NO(1-10): _

4. Enter card 01-10 then press #

NEWCARD: _ _ _ _ _

5. Present the card or fob in front of the black window, the system will register the card or fob 8-digit number printed then press #

NAME

see [Chapter 3](#) for keypad layout

6. Enter name and press #

DOOR(1,2,3):

7. Enter 1= relay 1(door 1), 2= relay 2 (door 2) or 3= both relay then press #

TMZ SET(1-3):

8. Enter time zone 1-3 then press #

TMZ NO(0-20): _ _

9. Enter 00 (*24 hours*) - 20 see [function code 17](#) then press #

SAT ID: _ _ _ _ _

10. Enter Sat ID 0-7 then press # (**enter 0 if no satellite connected to the QR5**)

Another(0-1): _

11. Enter
 0= no more additional time zone then press # and return to [step 3](#) to program another temporary code
 1= add additional time zone then press # and return to [step 8](#)
 * = exit programming

Function code 36 Special Card



The card can be use to unlock hold (open hold) and use same code again to lock (close) door or gate. Up to 10 special cards can be programmed.

1. [Log-in to programming](#)

2. Enter 36 then

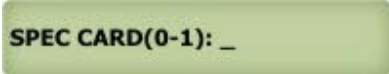

SPEC CARD(0-1): _

3. Enter 0= delete 1= add then press

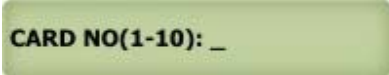

CARD NO(1-10): _

4. Enter code 01-10 then press



NEWCARD: _ _ _ _ _

5. Enter 4-8 digit code, see digit setting on [function code 09](#)

NAME



----- see [Chapter 3](#) for keypad layout

6. Present the card or fob in front of the black window, the system will register the card or fob 8-digit number printed then press

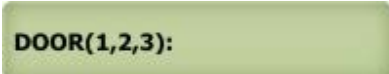

DOOR(1,2,3):

7. Enter 1= relay 1(door 1), 2= relay 2 (door 2) or 3= both relay then press

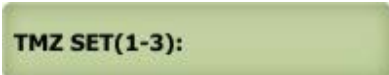

TMZ SET(1-3):

8. Enter time zone 1-3 then press

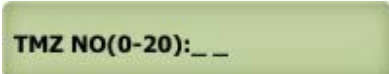

TMZ NO(0-20): _ _

9. Enter 00 (*24 hours*) - 20 see [function code 17](#) then press #

SAT ID: _ _ _ _ _

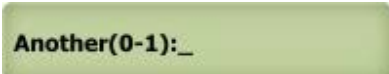
10. Enter Sat ID 0-7 then press # (**enter 0 if no satellite connected to the QR5**)

Another(0-1): _

11. Enter

0= no more additional time zone then press # and return to [step 3](#) to program another temporary code

1= add additional time zone then press # and return to [step 8](#)

* = exit programming

Function Code 38 System Acknowledge



The system will answer incoming outside call after the number of rings set. If the line associated with the system is connected to fax machine, alarm panel or any answering device. Disable this function.

1. [Log-in to programming](#)
2. Enter 38 then #

SYS ACK(0-9):0

3. Press
0= disable auto answer
1-9= answer in 1-9 rings
then press #

Function Code 39 Disable and Enable Remote Access



If no remote opening allow, disable it using this function code. Default setting is enabled.

1. [Log-in to programming](#)
2. Enter 39 then #

DTMF ACC(0-1):1

3. Press
0= disable remote access
1= enable remote access (default)
then press #

Function Code 40 DTMF Relay 1



*By default the DTMF remote opening relay 1 (door 1) key number is set to 9 means pressing 9 will remotely trigger relay 1 (door 1). The number can be changed by selecting 1-9 to trigger relay 1 (door 1). **Note:** by default remote access for relay 2 is set to 8, see [function code 41](#). If you set relay 1 for key number 8 then you **MUST** change relay 2 to different key number even though relay 2 is not used.*

1. [Log-in to programming](#)

2. Enter 40 then #

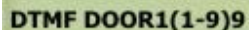
A green rectangular button with the text "DTMF DOOR1(1-9)9" in black.

3. Press 1-9 (9 is default setting) then press #

Function Code 41 DTMF Relay 2



*By default the DTMF remote opening relay 2 (door 2) key number is set to 8 means pressing 8 will remotely trigger relay 2 (door 2). The number can be changed by selecting 1-9 to trigger relay 2 (door 2). **Note:** by default remote access for relay 1 is set to 9, see [function code 42](#). If you set relay 2 for key number 9 then you **MUST** change relay 1 to different key number even though relay 1 is not used.*

1. [Log-in to programming](#)

2. Enter 41 then #

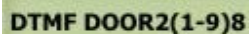
A green rectangular button with the text "DTMF DOOR2(1-9)8" in black.

3. Press 1-9 (9 is default setting) then press #

Function Code 42 Relay 2 Mode



Relay 2 can be set to four different mode: 1= door control, 2= trigger simultaneously as relay 1, 3= alarm mode (see [function code 24](#)), 4= turn relay 2 on/off remotely (DTMF key 7/6)

1. [Log-in to programming](#)

2. Enter 42 then #

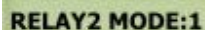
A green rectangular button with the text "RELAY2 MODE:1" in black.

3. Enter
1= door control, 2=trigger simultaneously as relay 1, 3= alarm mode (see [function code 24](#)), 4= turn relay 2 on/off remotely (DTMF key 7/6), then press #

Function Code 43 Do Not Disturb Time Zone



If you do not want to be disturbed from someone calling you from the system during certain hours of the days, you can create Do Not Disturb Time Zone. For example: 22:00-06:00 Monday-Sunday. Up to 10 Do Not Disturb Time Zones can be programmed.

1. [Log-in to programming](#)

2. Enter 43 then #

DND NO(0-9):_

3. Enter 0-9 then press #

ADD=1 DEL=0:_

4. Enter 0= delete, 1= add then press #

START TIME: _ _ _ _

5. Enter start time (military time) the press #

END TIME: _ _ _ _

6. Enter end time then press # (military time, end time must be later than start time, if start time: 22:00 hour and end time: 06:00, two time zone must be created (22:00 hour - 24:00 hour, 00:01 hour 06:00 hour)

DAY(0-6): _ _ _ _ _ _

7. Enter

0= Sunday, **1**= Monday, **2**= Tuesday, **3**= Wednesday, **4**= Thursday, **5**= Friday, **6**= Saturday then press #

8. [Return to step 3](#) to program another time zone

Function Code 44 Disable Time Zone Relay



The system's relay can be disabled during certain time but the system is still in full operation. Maximum 10 disable time zones.

1. [Log-in to programming](#)

2. Enter 44 then #

DISABLE(0-9):_

3. Enter 0-9 then pres #

ADD=1 DEL=0: _

4. Enter

0= Delete the existing time zone then press #

DELETED

or

1= add new time zone then press #

START TIME: _ _ _ _

5. Enter start time in military then press #

END TIME: _ _ _ _

6. Enter end time in military then press #

DAY(0-6) _ _ _ _ _

7. Enter

0= Sunday, **1**= Monday, **2**= Tuesday, **3**= Wednesday, **4**= Thursday, **5**= Friday, **6**= Saturday
then press #

[Return to step 3 to program more time zone](#)

Function Code 45 Relay 1 and 2 Unlock Timer

Relay 1 and 2 can be unlock using count down timer 01-98 hours or 00=lock or 99= unlimited unlock hold.

1. [Log-in to programming](#)

2. Enter 45 then #

WHICH DOOR: _

3. Enter relay 1 (door 1) then press #

DOOR1 HOURS:00

then press #

or relay 2 (door 2) then press #,

DOOR2 HOURS:00

then press #

Function Code 46 Firmware Version



To check the system's firmware version

1. [Log-in to programming](#)
2. Enter 46 then #

V2.0 09/09/11

Function Code 48 PBX Enable



If the system is installed behind a Private Branch Exchange (PBX) then 9 is necessary before dialing an outside line. If this function is enabled then the system can only be dialing an outside line, it cannot dial the extension.

1. [Log-in to programming](#)
2. Enter 48 then #

PBX EN(0-1):0

3. Enter 0= disable or 1= enable then press #

PBX NUM:9

4. Enter the number to access dial tone to dial an outside line, generally 9 is the default number for most PBX system, then press #

Delay(1-5s):5

5. Select delay time for the PBX system to access dial tone, generally 2-3 second delay is plenty of time, then press #

Function Code 49 Edit Existing Access Code, Temporary Code and Special Code



1. [Log-in to programming](#)

2. Enter 49 then #

CODE: _ _ _ _

3. Editing an Access Code [click here](#) or
Editing a Temporary Code, [click here](#) or
Editing a Special code, then [click here](#)

Function Code 50 Erase Memory to Factory Default



Warning: *This function code will erase the memory to factory default, no way to restore them unless the database has been saved in the computer.*

1. [Log-in to programming](#)

2. Enter 50 then #

MEM DEFAULT(1):_

3. Enter 0= cancel or 1= continue then press #

MEM DEFAULT WAIT

Function Code 51 Welcome Screen



It consists of three segments and 16 characters for each segment

1. [Log-in to programming](#)

2. Enter 51 then #

***PRESS 3 or 6

3. 1st segment, enter the characters then press # see [Chapter 3](#) for keypad layout

_to scroll. Pres

4. 2nd segment, enter the characters then press # see [Chapter 3](#) for keypad layout

CHAPTER 5

Operations



5.1 Call from the System

1. **Direct Call:** press # then directory code, see [function code 19](#)
2. **Scrolling:** press 3 or 6 to scroll name then press # to call the selected name

5.2 Opening Door Remotely

Relay 1 (door 1), press 9

Relay 2 (door 2), press 8

5.3 Opening Door Using Access Code, Temporary Code, and Special Code

Access code Standard Operation is keyless entry code to open the door and door will be closed automatically, see [function code 06](#)

Temporary Code is used for limited number of times, maximum 10 times then the code will be expired, see [function code 33](#)

Special Code is used to unlock hold door and then use same code to lock the door, see [function code 34](#)

Press * (display will stop scrolling) then press the 4, 5, 6, 7 or 8 digit access code as programmed on [Function Code 09](#)

5.4 Opening Door Using Card, Temporary Card, and Special Card

The Quantum Q9000VOIP Series Series Series has built-in card reader. The door can be access using UFOB, UCLAM or UISO.

Card Standard Operation is used to open the door and door will be closed automatically, see [function code 10](#)

Temporary Card is used for limited of times, maximum 10 times then the card will be expired, see [function code 35](#)

Special Card is used to unlock hold door and then use same card to lock the door, see [function code 36](#)



Pach and Company UFOB, UCLAM and UISO must be used to have access to the card reader. Other manufacturers card will not work.

Swipe the card as shown below. The card reader antenna is mounted behind the black square window.



5.5 Opening Door Using Transmitter, Temporary Code Transmitter, and Special Code Transmitter

*The Quantum Q9000VOIP Series Series Series has optional Radio Frequency (RF) Receiver. The transmitter will work in 300 feet radius open air with the transmitter antenna fully extended. The distance may vary depending on the environment. **Transmitter Standard Operation** is used to open the door and door will be closed automatically, see [function code 10](#) **Temporary Transmitter** is used for limited of times, maximum 10 times then the transmitter will be expired, see [function code 35](#) **Special Transmitter** is used to unlock hold door and then use same transmitter to lock the door, see [function code 36](#)*



Pach and Company RF Transmitter must be used to have access to the card reader. Other manufacturers transmitter will not work.



Press A, B, C or D button, red LED will be On
Extend the antenna for longer distance transmission

5.6 Extending Talk Time

The talk time timer is set on [function code 27](#). The warning beep will be heard one minute before the talk time is expired. It can be extended more another full cycle by pressing #

5.7 Call the System from Remote Location

1. *The system must be install in [Intercom and Call Forwarding Mode Wiring Diagram](#) or [Call Forwarding Mode wiring Diagram](#)*
2. *[Function code 38](#) must be set at least for 1 ring*
3. *[Function code 39](#) must be set to 1*
4. You must have the system phone number
5. Call the system phone number if the system answered, short beep will be heard.
6. Press # then 4-digit Master code (default is 0000), short beep will be heard if master code is accepted
7. Press * to establish two ways communication

8. Press 9 to release relay 1 (door 1) or 8 to release relay 2 (door 2).

CHAPTER 6

QWCM Internet IP Module



The QWCM is only applicable for QR5IP. Click [here](#) for complete manual for QWCM

QR5IP DEFAULT SETTING

IP: 192.168.1.230

SUBNET: 255.255.255.0

GATEWAY: 192.168.1.1

DNS: 192.168.1.1

USERNAME: Administrator

PASSWORD: 8888